

Small Incision - Optimal Exposure

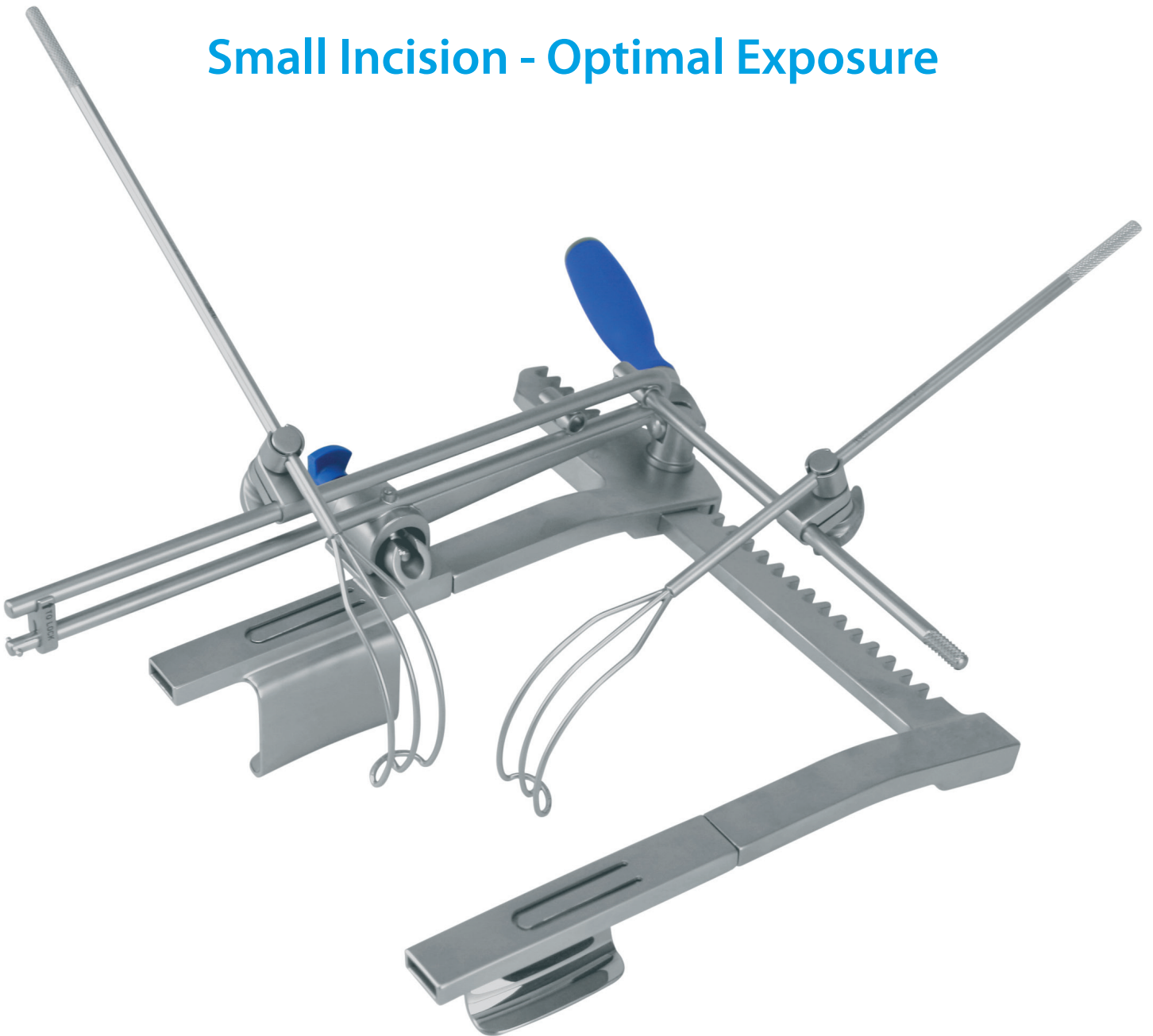

Adams Retractor

Adams Retractor

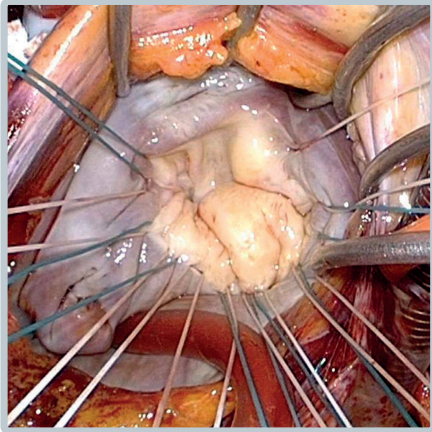

"The lateral displacement system optimizes the working mitral access area without the need for additional sternal spreading."

Dr. David Adams

Multiple Sternal Blade Sizes

Enhance Exposure with Lateral Displacement

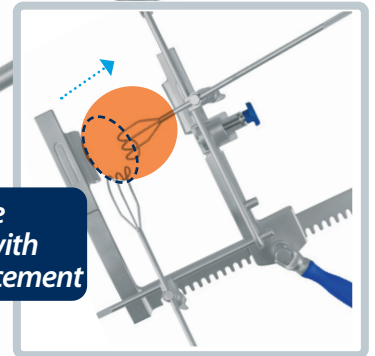

○ Initial exposure
● Exposure after adjustment

Adjustable Positioning

Clipsable Lateral Bracket



Two positions

DC30150-01

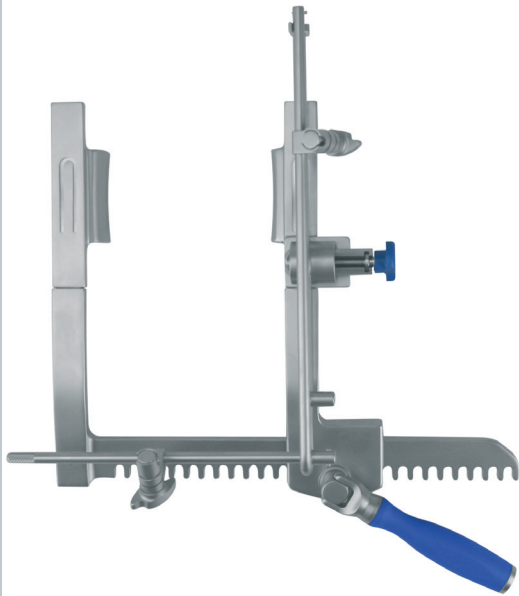

Adams Retractor (Rack Down)

NEW

- ✗ Dimensions: c: 190 mm - d: 180 mm
- ✗ Rack-up also available: DC30150-02
- ✗ Included with sternal retractor:
 - 3 attachment brackets for hook



- 3 pairs of sternal blades with adaptor



a: 50 mm - b: 30 mm

a: 50 mm - b: 40 mm

a: 70 mm - b: 40 mm

- ✗ Wider sternal blades available on DC30150-03

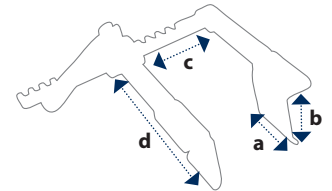

Adams Mitral Hooks Set

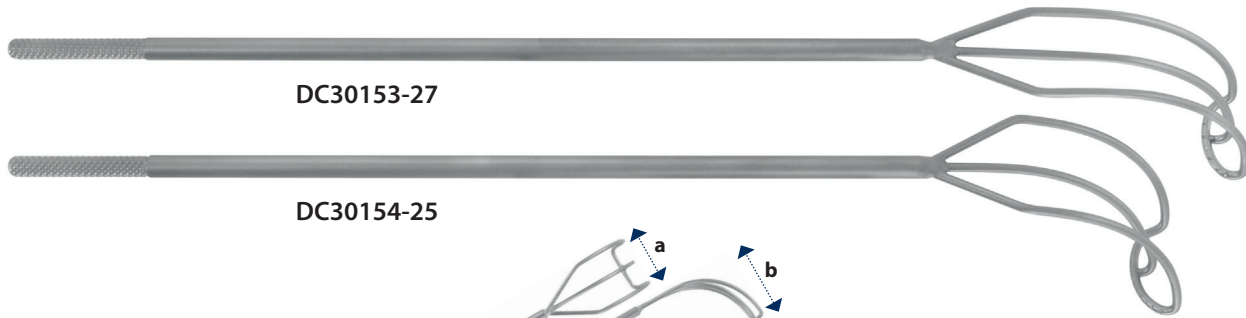

DC30153-27

DC30154-25

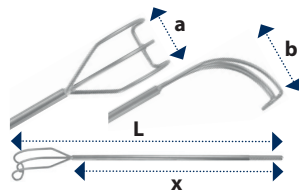

2 x **DC30153-27**

Adams long and thin hook

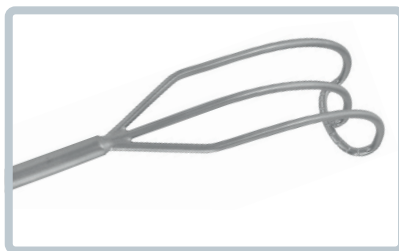

a: 20 mm - b: 34 mm

L: 270 mm - x: 200 mm

+ 1 x **DC30154-25**

Adams medium hook

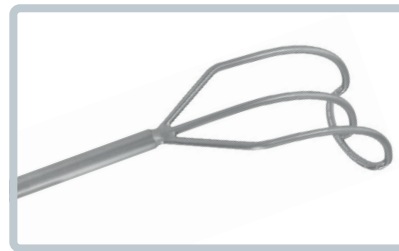

a: 26 mm - b: 34 mm

L: 250 mm - x: 200 mm

All the hooks available

Adams long and thin hook

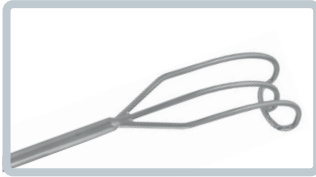

a: 20 mm - b: 34 mm

DC30153-22

L: 220 mm - x: 150 mm

 **DC30153-27**

L: 270 mm - x: 200 mm

Large hook

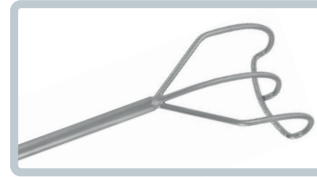

a: 35 mm - b: 34 mm

DC30155-20

L: 200 mm - x: 150 mm

 **DC30155-25**

L: 250 mm - x: 200 mm

Adams medium hook

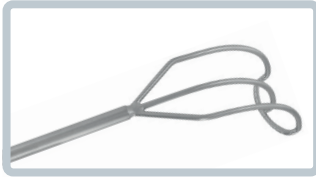

a: 26 mm - b: 34 mm

DC30154-20

L: 200 mm - x: 150 mm

 **DC30154-25**

L: 250 mm - x: 200 mm

Tricuspid hook

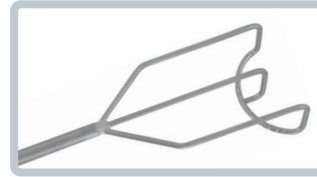

a: 35 mm - b: 16 mm

DC30156-22

L: 220 mm - x: 150 mm

 **DC30156-27**

L: 270 mm - x: 200 mm

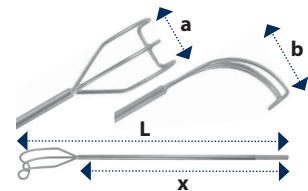

Adams Recommended Set

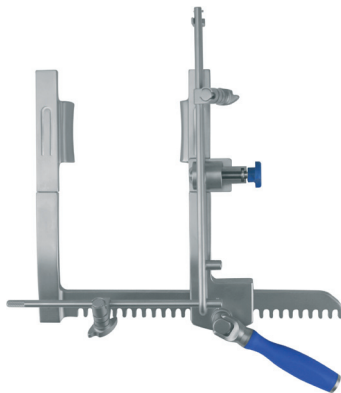

DC30150-01

Adams retractor



2 x DC30153-27

Adams long and thin hook



+ 1 x DC30154-25

Adams medium hook

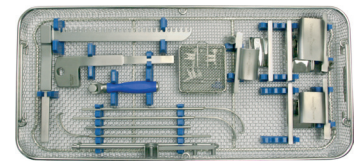

1 x DC30159-00

Large basket with lid (540 x 240 x 100 mm)
For Adams retractor and three hooks
Instruments not included

Delacroix-Chevalier
Paris

Head Office

217, rue du Faubourg Saint Honoré - 75008 Paris - France

Customer Service

Rue Renée et Louis Landanger

CS 52152 - 52906 Chaumont Cedex 9 - France

Phone: +33 (0) 3 25 02 10 35 - Fax: +33 (0) 3 25 02 10 20 - Email: export@delacroix-chevalier.com - www.delacroix-chevalier.com